

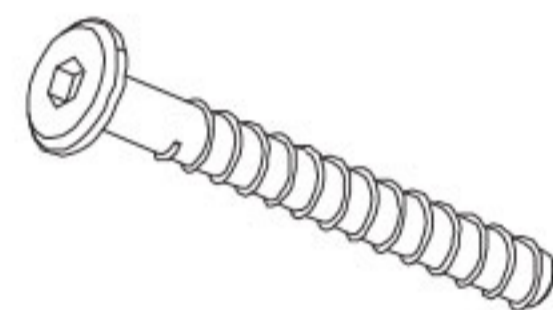





Read the instructions carefully. Remove all the wrappings , staples and straps from the carton. Refer to the hardware and furniture part list for guidance. Make sure that you have all the parts before you start assembling. Place all the wooden furniture parts on a clean, flat and soft surface, such as a carpet or rubbermat to prevent scratches.

CAUTION
KEEP ALL THE PARTS OUT OF CHILDREN'S REACH.

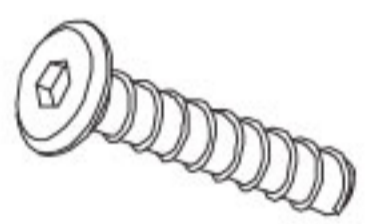
ITEM	PHOTO	HAREWARE NAME	QTY
(A)		JCBC M6x50mm	4
(B)		JCBC M6x40mm	1
(C)		JCBC M6x30mm	1
(D)		Barrel Nut	1
(E)		Nut	1
(F)		Pan Head Screw	1
(G)		Allen Key	1
(H)		Castor U Lock	1
(J)		Castor U	1

ITEM	PHOTO	PARTS NAME	QTY
(1)		Headboard	1
(2)		Footboard	1
(3)		Side Panel	1
(4)		Drop Side Panel	1
(5)		Mattress Support	1
(6)		Mattress Board	1

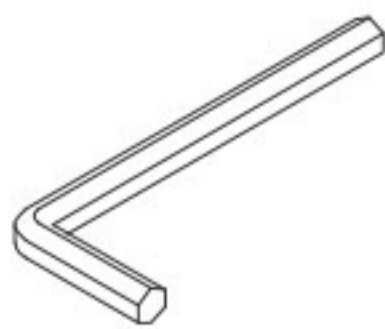
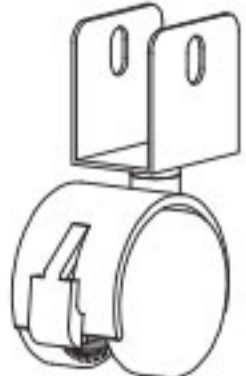
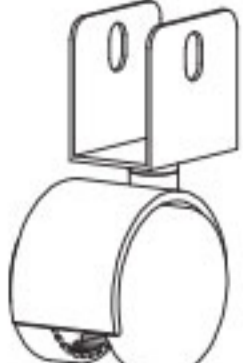
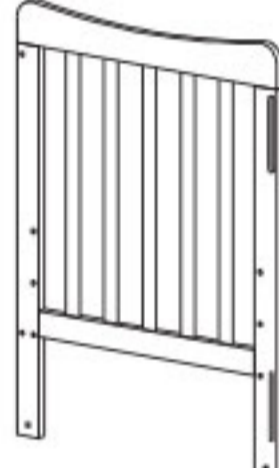
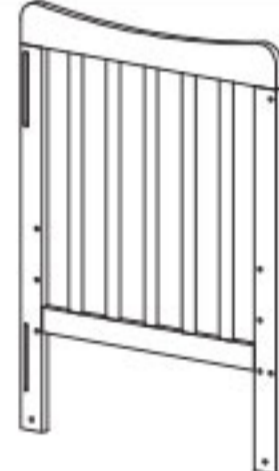
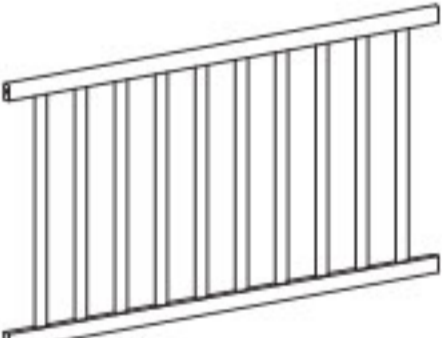
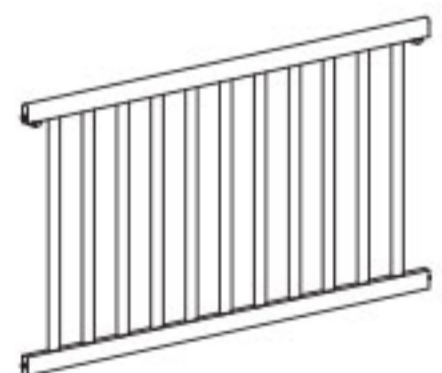
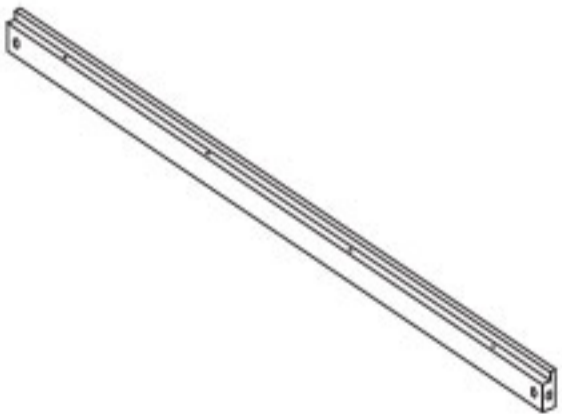
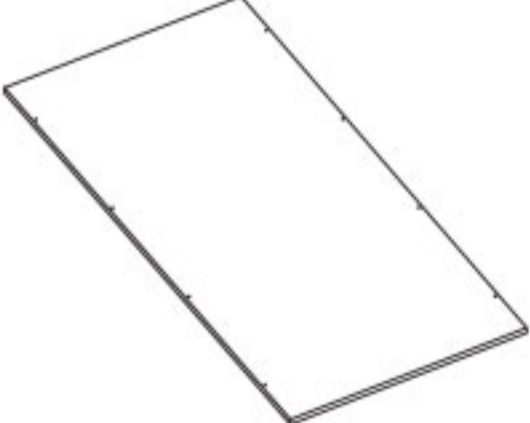
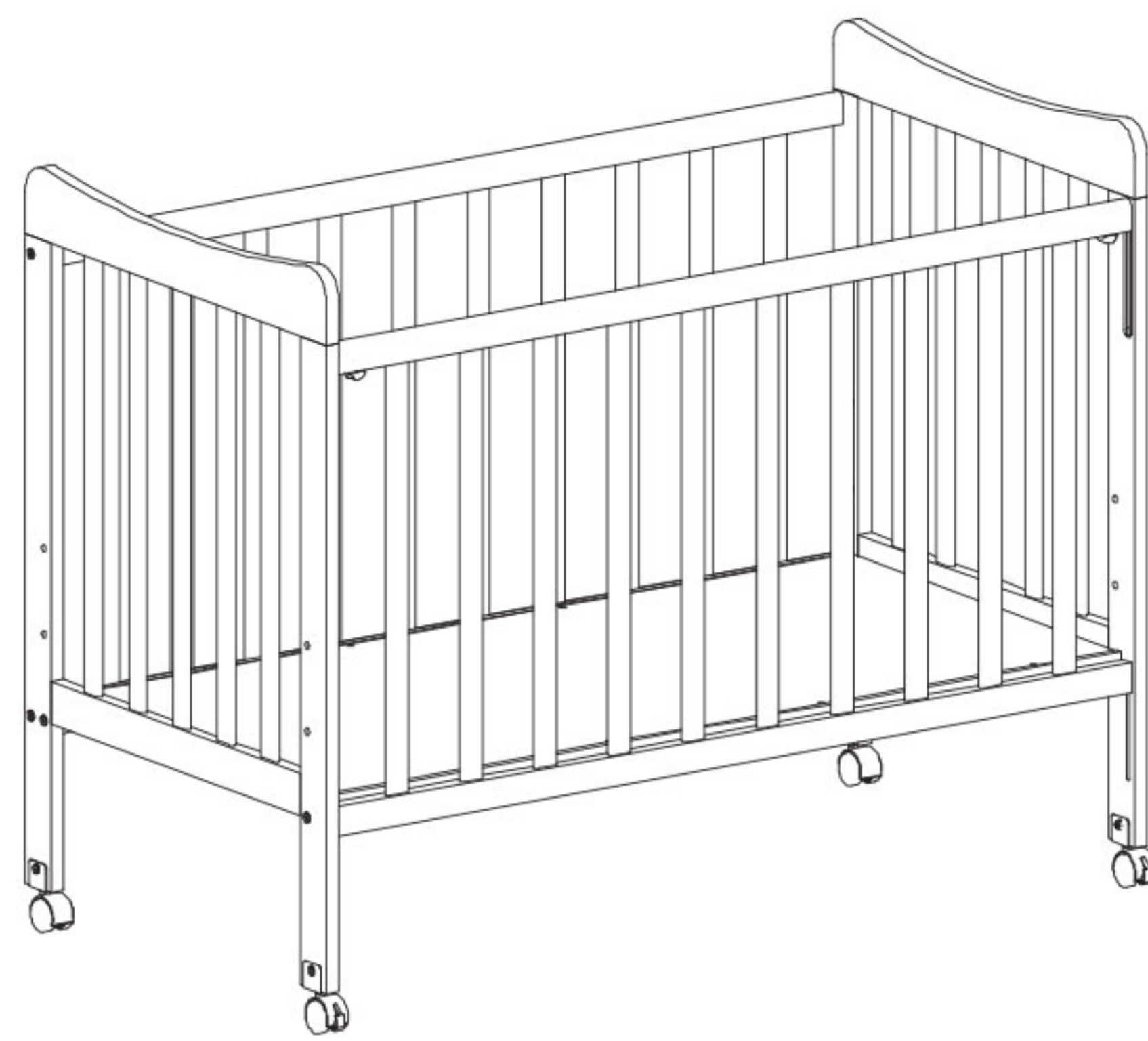

1

Step 1: Attaching Mattress Board to Mattress Support.

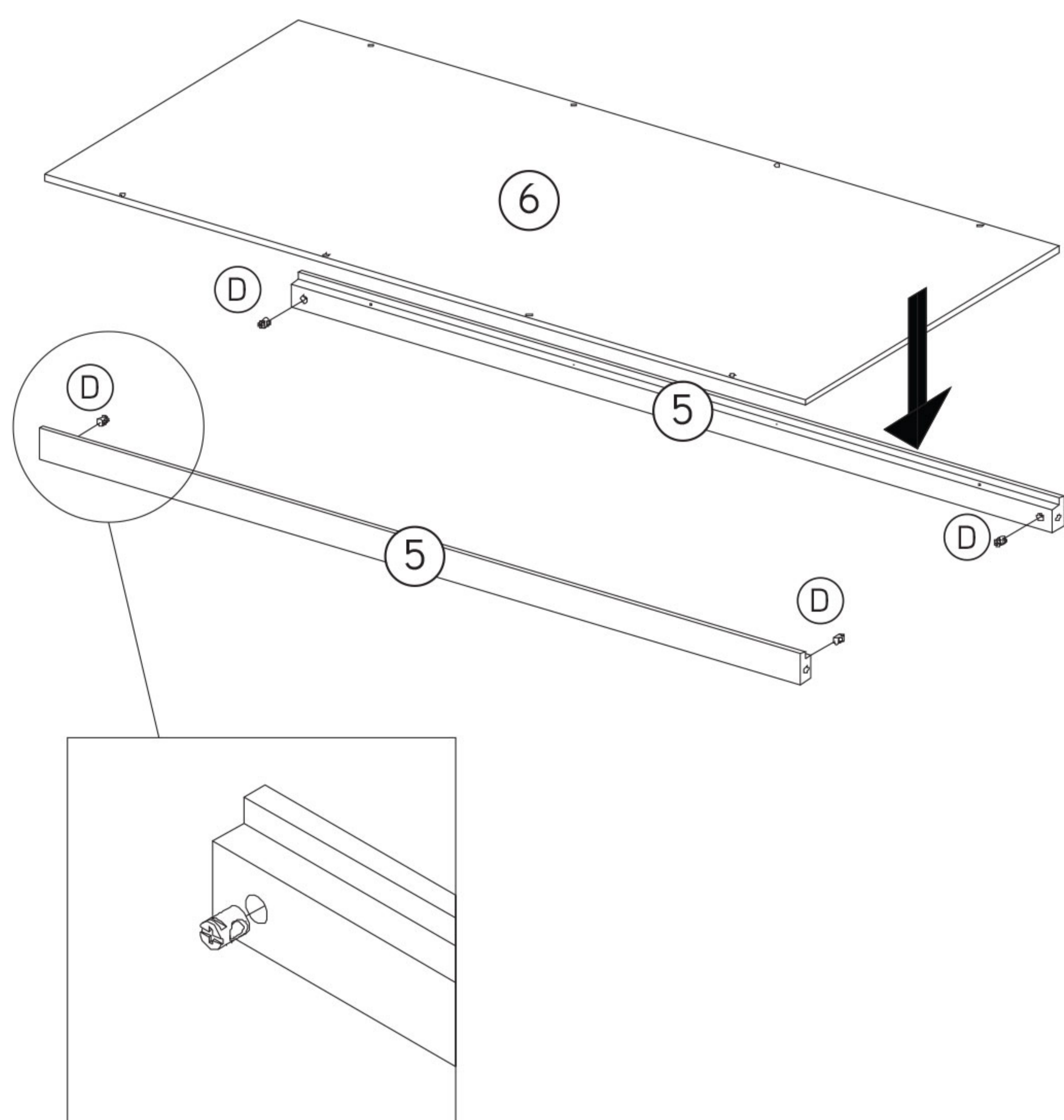

2

Step 2: Attaching the Mattress Board

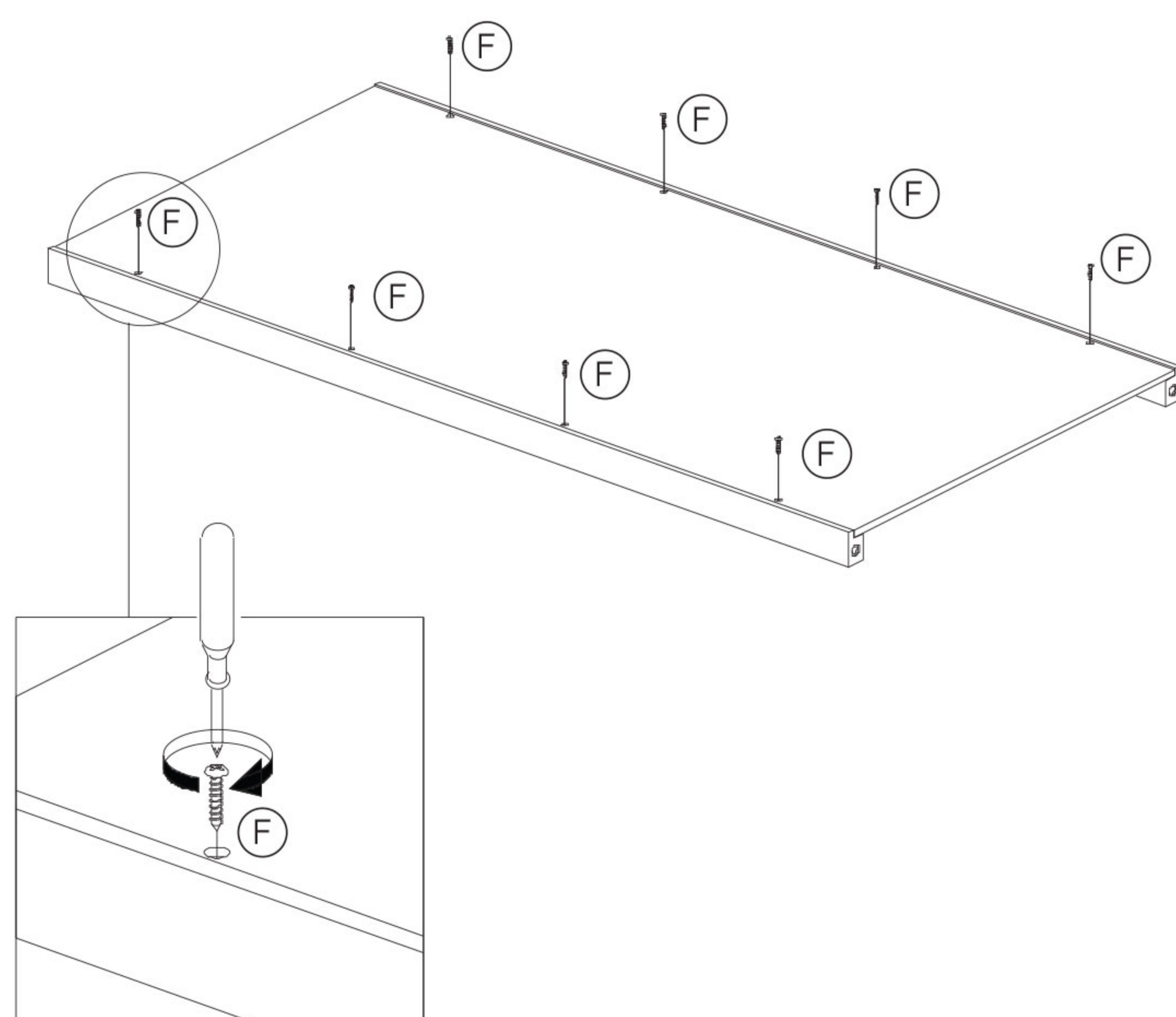

3

Step 3: Attaching Side Panel to Headboard & Footboard.

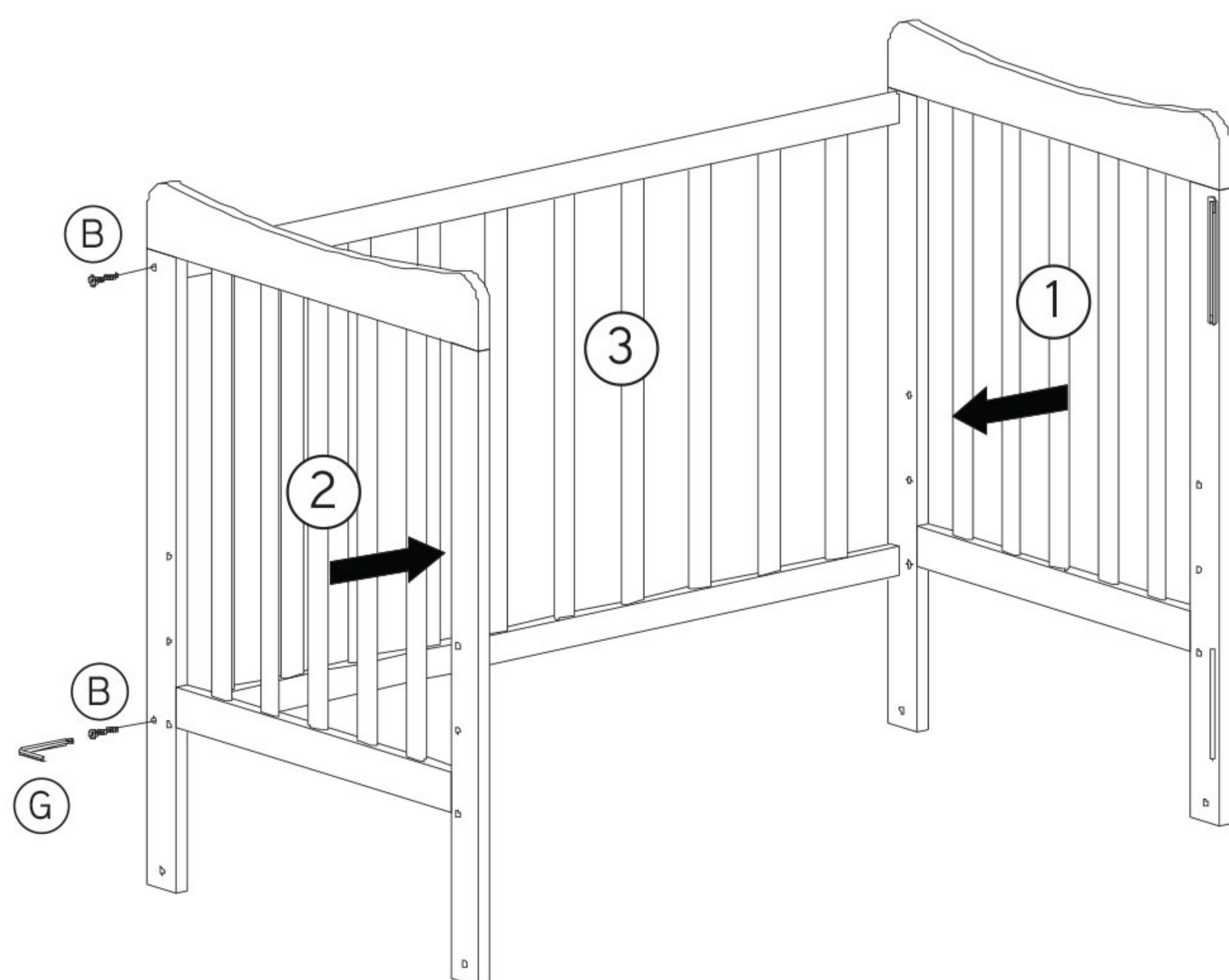

4

Step 4: Attaching the Mattress Base

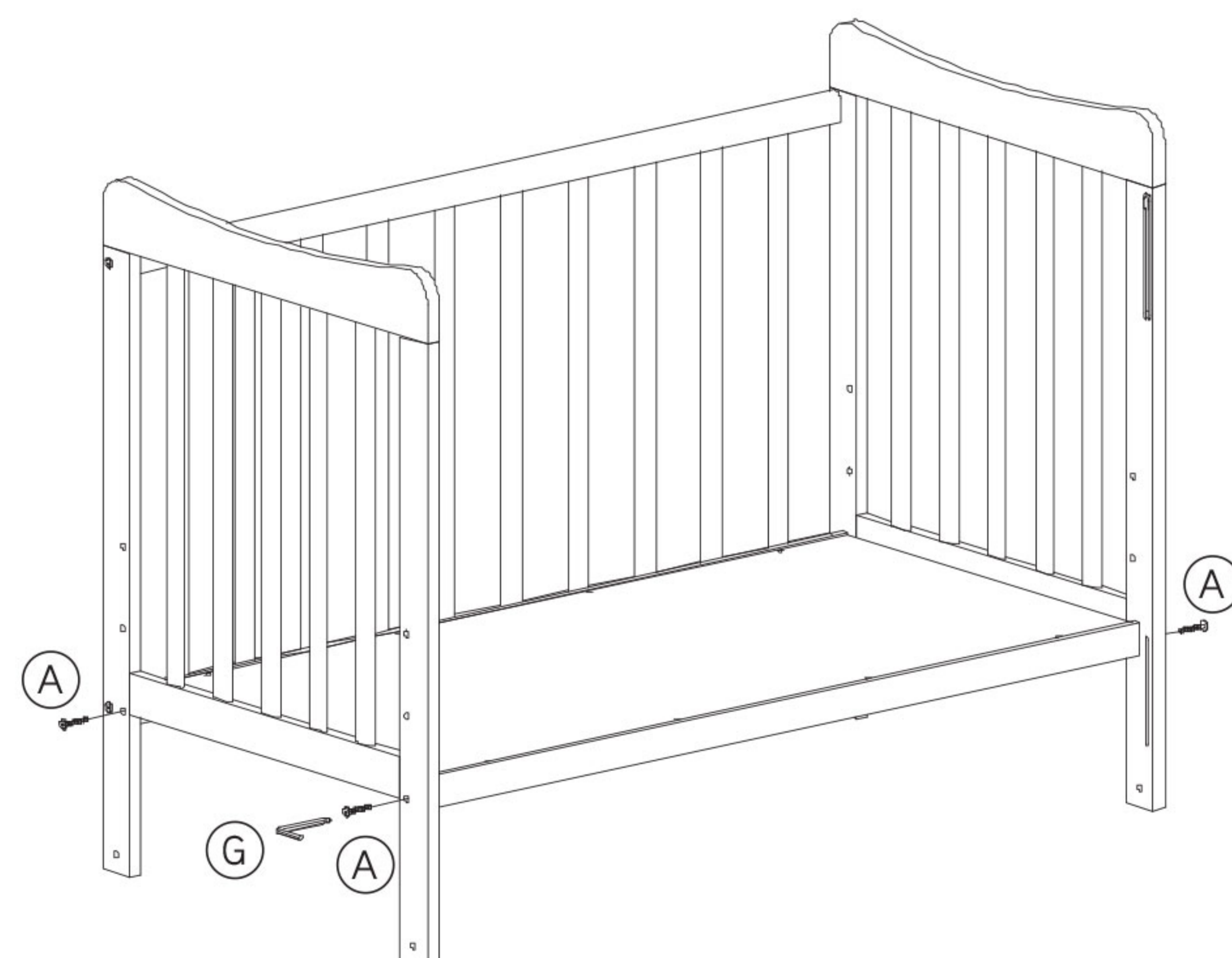

Note: To allow the fitting of the Drop Side Panel do not tighten fully at this stage

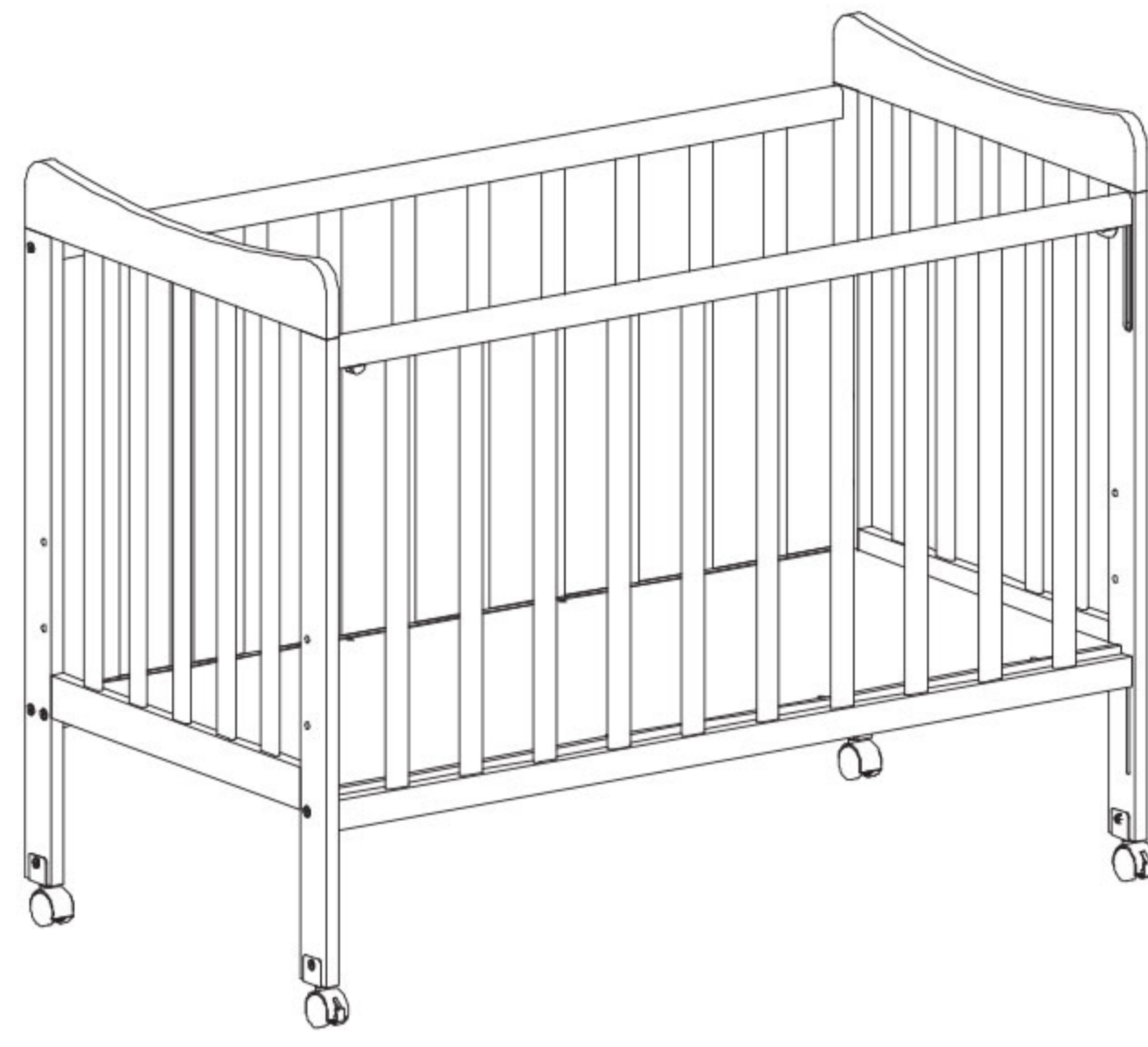

5

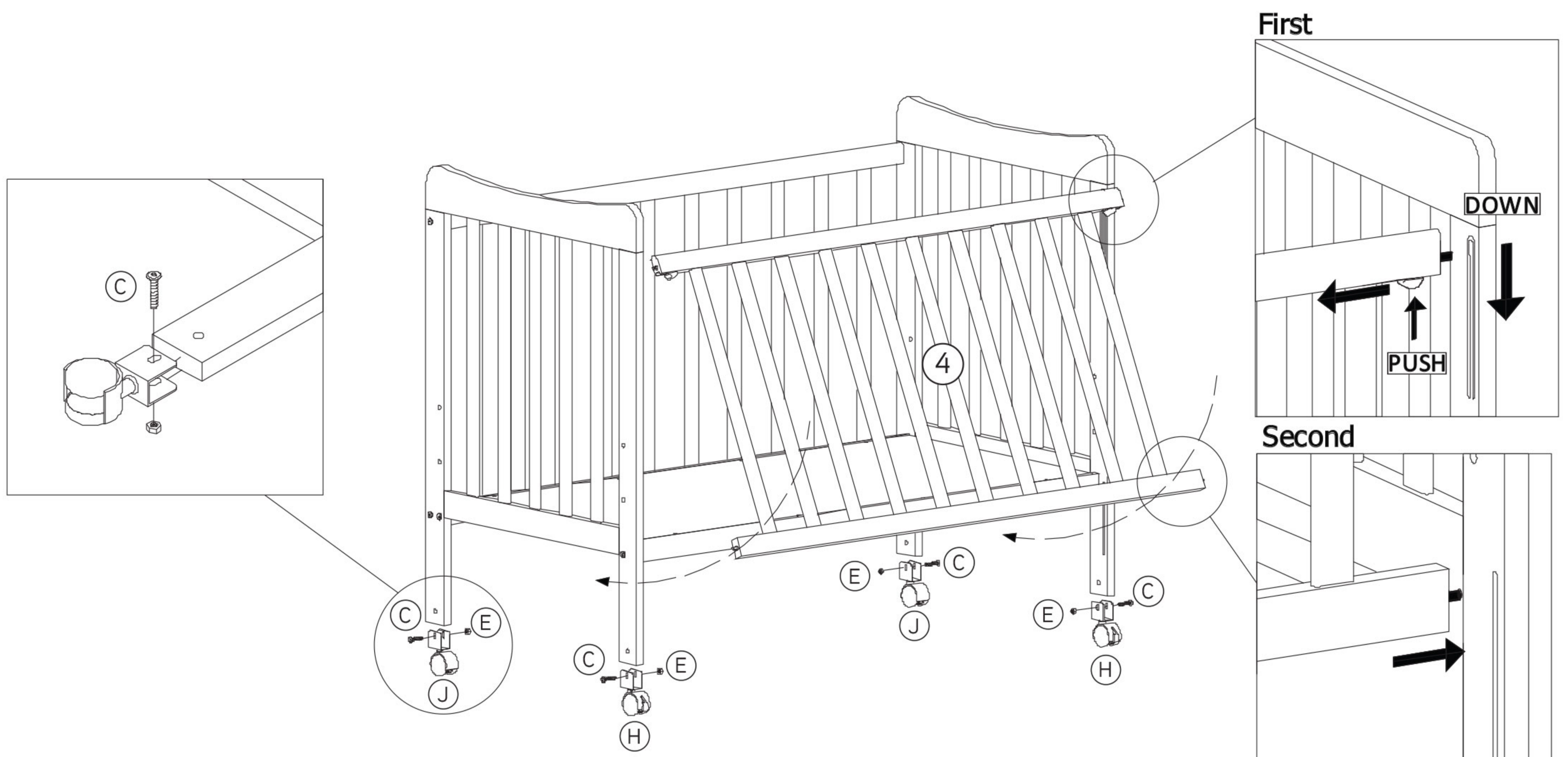

Note: Fully tighten the 4 side panel, screws after all panel has been assemble.